

**REMEDIAL ACTION PLAN
QUALITY ASSURANCE PROJECT PLAN
UP PROVO LINE VCP
UTAH VCP C108
1000 WEST 500 SOUTH
SALT LAKE CITY, UTAH**

Project No. 2493-001

Prepared For

**Salt Lake City Metro, LLC
750 The City Drive, Ste 320
Orange, California 92868**

July 27, 2023

Prepared by

**Wasatch Environmental, Inc.
2410 West California Avenue
Salt Lake City, UT 84104**



**Christopher J. Nolan, P.G.
Senior Project Geologist**

TABLE OF CONTENTS

<u>Section</u>	<u>Page No.</u>
1. INTRODUCTION.....	2
1.1 Site History.....	2
1.2 Summary of Site Investigation Activities.....	2
1.3 Conceptual Site Model and Exposure Pathways.....	3
2. CONTAMINANTS OF CONCERN / ACTION LEVELS	4
3. REMEDIAL OBJECTIVES AND APPROACH.....	4
4. CONFIRMATION SAMPLING AND ANALYSIS.....	5
5. POST REMEDIATION REPORTING	6
5.1 Remedial Action Completion Report.....	6
6. ADDITIONAL INFORMATION	7
6.1 Project/Task Organization.....	7
6.2 Project Task Description	7
6.4 Special Training/ Certifications	7
6.5 Sampling Process Design.....	8
6.6 Sampling Methods	8
6.7 Sampling Handling and Custody.....	8
6.8 Analytical Methods.....	9
6.9 Quality Control	9
6.10 Equipment Testing, Inspection, and Maintenance.....	9
6.11 Equipment Calibration.....	9
6.14 Fugitive Emissions Monitoring Plan	9
6.15 Site Access	10
6.16 Contingency Plan	10
6.17 Public Notice and Community Outreach	10
6.18 Health and Safety Plan	11
6.19 Storm Water Low Erosivity Waiver Certification	11

Tables

Table 1 – Conceptual Site Model

Table 2 – Proposed Action Levels for PAHs

Figures

Figure 1 – Vicinity Map

Figure 2 – ALTA/NSPS Land Title Survey – North

Figure 3 – ALTA/NSPS Land Title Survey - South

Figure 4 – Soil and Groundwater Sample Location Map

Figure 5 – Confirmation Sample Location Map - North

Figure 6 – Confirmation Sample Location Map - South

Appendices

Appendix A – Standard Operating Procedures

Appendix B – Quality Assurance Project Plan

Appendix C – Fugitive Emissions Monitoring Plan

Appendix D – Health and Safety Plan

Appendix E – Storm Water Low Erosivity Waiver Certification

**REMEDIAL ACTION PLAN
UP PROVO LINE VCP
SALT LAKE CITY, UTAH**

1. INTRODUCTION

At the request of Salt Lake City Metro, LLC, Wasatch Environmental, Inc., (Wasatch) has prepared this Remedial Action Plan (RAP) to be implemented during the soil remediation Voluntary Cleanup Program (VCP) project located at approximately 1000 South 500 West, Utah (Figure 1). The Property has been accepted into the Utah Voluntary Cleanup Program (VCP C108) to address environmental impacts identified in site soils.

The post remediation development plans call for site re-grading and asphalt paving on portions of the Project. A copy of the ALTA survey is attached as Figures 2 and 3.

1.1 Site History

The Property consists of 2.3 acres and is a former passenger rail line. The Property is approximately 2,200 feet long and averages 60 feet in width. The Property rail line consists of a ballast bed, wooden ties, and steel rails. Some signal and switching equipment are also present.

Research during completion of a Phase I Environmental Site Assessment indicates that the rail spur has been present at the Property since at least 1911. There was no information found to suggest that any additional railroad infrastructure was present.

Between April 17, 2023, and April 26, 2023, AK Railroad removed the rail, rail plates, spikes, and ties from the Property. All the metal was retained by AK Railroad as salvage. The majority of the wood ties were also retained by AK Railroad for sale. A small amount of damaged ties was disposed of at the Salt Lake County landfill. No soil or ballast was removed during AK Railroads work. Periodic inspections of the work were made by Wasatch and no trackout or fugitive dust issues were observed during the rail and tie removal.

1.2 Summary of Site Investigation Activities

In August and September 2020, Wasatch completed a Limited Site Investigation (LSI) at the subject property which consisted of advancing seven soil borings to investigate soil conditions; the collection of groundwater samples for laboratory analysis; excavating 21 shallow test pits to a depth of approximately 1 to 5 feet below ground surface (bgs) to screen soils with a hand held X-ray Fluorescence (XRF) meter to measure concentrations of heavy metals (mainly arsenic and lead); and to collect soil samples for metals analysis. The soil boring and test pit locations are provided on Figure 4.

No volatile organic compounds (VOCs), total petroleum hydrocarbons-gasoline range organics (TPH-GRO), or polycyclic aromatic hydrocarbons (PAHs) were detected in any of the groundwater samples at concentrations above the laboratory reporting limits. TPH-diesel range organics (DRO) was reported in sample GW-4 (collected from boring GP-4) at a concentration of 0.726 milligrams per liter (mg/L), which is below the Utah Initial Screening Level for TPH-DRO of 1.0 mg/L. All other TPH-DRO analytical results were below the laboratory reporting limit.

The U.S. Environmental Protection Agency (EPA) residential Regional Screening Level (RSL) for arsenic in soil of 0.68 milligrams per kilogram (mg/kg) was exceeded in all samples collected from the shallow non-native ballast and fill materials. Sample results ranged from 15.55 parts per million (ppm) to 223.45 ppm. The background concentrations for arsenic in the Salt Lake Valley typically range between 3 and 35 mg/kg. None of the samples contained Resource Conservation and Recovery Act (RCRA) D-list metals greater than the toxicity characteristic leaching protocol (TCLP) limits; therefore the materials

would not be classified as a hazardous waste for disposal purposes; however, based on the arsenic and lead concentrations, the materials would need to be disposed of at an appropriate, licensed landfill.

The concentrations of arsenic and lead are well within background concentrations in the native soil and vary greatly within the ballast and fill materials. Gravel size slag material used as ballast which is visible on the ground surface exhibited lead concentrations ranging from 536 ppm to 10,308 ppm and arsenic concentrations ranging from less than the level of detection (LOD) to 146 ppm. Much of the fill material does not exhibit elevated arsenic and/or lead at depths below 0.5 feet.

Based on the XRF and laboratory results of these investigations, arsenic and lead are present in shallow ballast and fill materials at concentrations greater than the U.S. EPA RSL for residential soil. Groundwater does not appear to be impacted by VOCs/TPH-GRO, PAHs, or TPH-DRO. .

On March 22, 2021, Wasatch collected additional soil and groundwater samples. The groundwater samples were analyzed for the following analytes:

- Hexavalent Chromium using U.S. EPA Method 7199,
- Mercury using U.S. EPA Method 7470A, and
- RCRA Metals U.S. EPA Method 6010B.

The soil samples were analyzed for the following analytes:

- Hexavalent Chromium using U.S. EPA Method 3060A/7196A, and
- PAHs with select ion monitoring (SIM) using U.S. EPA Method 8270C-SIM.

In groundwater, arsenic was detected at 0.0251 milligrams per liter (mg/L) in the GW-5A sample. Arsenic was not identified at greater than the laboratory reporting limits in the 3 groundwater samples collected near Pax Fertilizer (GW-1A, GW-2A, and GW-3A). All the detected metals concentrations in groundwater are well below, or within, their applicable Utah Groundwater Quality Standards. No other analytes were detected in any of the samples, and all laboratory reporting limits were below the Utah Groundwater Quality Standards.

In soil, naphthalene was detected at 0.0208 milligrams per kilogram (mg/kg) and 2-methylnaphthalene detected at 0.0222 mg/kg in sample GP-3A @ 8'. All the detected concentrations are well below, or within, their applicable U.S. EPA Regional Screening Levels (RSL) for residential properties. No other PAH analytes were detected in any of the samples, and all laboratory reporting limits were below the U.S. EPA RSL for residential soils. All soil samples for hexavalent chromium were below the laboratory limits of 0.640 mg/kg. Although this value is greater than the U.S. EPA Residential RSL concentration of 0.3 mg/kg, it appears that hexavalent chromium is not an issue at the Property.

All personnel involved with the collection and handling of environmental samples shall be required to read this plan, and a copy of this plan will be available in the field during all sampling activities.

1.3 Conceptual Site Model and Exposure Pathways

A Conceptual Site Model has been prepared to identify the site specific risks associated with the historical contamination sources, the existing contaminants of concern to be addressed during the remediation, contaminated media, transport pathways, exposure route, and potentially exposed receptor populations. The historical contamination sources are the use of slag containing lead and arsenic as rail ballast and the wind deposition of coal and coal combustion by product used by locomotives and presence of creosote rail ties which resulted in PNA impacts. The contaminants of concern are lead, arsenic and PNAs. The contaminated media is rail ballast (including ties) and soil located immediately underlying the rail ballast. Transport pathways, especially during remediation, is suspension of dust containing the impacted soil resulting in an exposure route of inhalation and to a lesser degree ingestion of dust.

Exposed populations include remediation workers and future residents and employees. A graphical representation of the Conceptual Site Model is presented as Table 1.

SOURCE

INTERACTION

RECEPTORS

Contamination

Exposure Medium

Transport Pathway

Exposure Route

Current Use	Future Use	
Remediation Worker	Employee	Resident

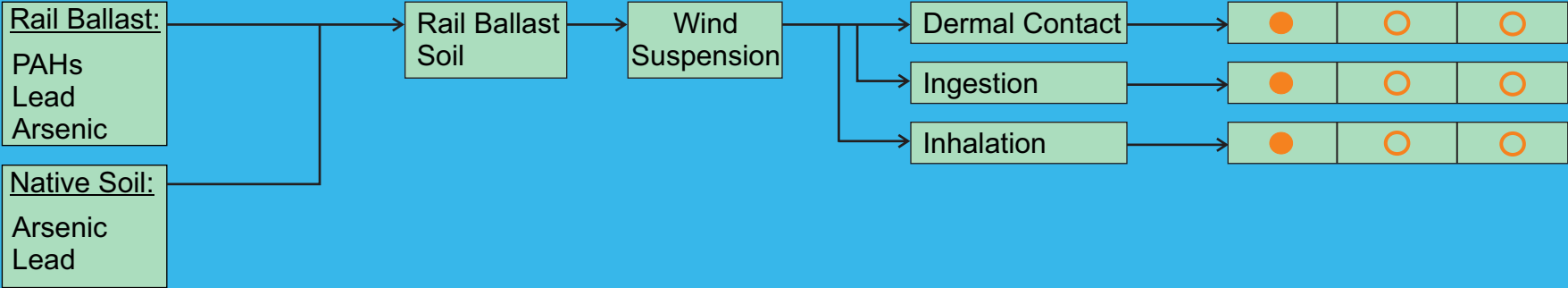

- Complete Pathway
- Incomplete Pathway

Conceptual Site Model | Table 1

2. CONTAMINANTS OF CONCERN / ACTION LEVELS

The Action Levels for unrestricted use at the UP Rail Line VCP project will be 400 mg/kg for total lead and 35 mg/kg for arsenic. The lead Action Level is the U.S. EPA RSL for residential use. The Action Levels for the PAH compounds will be the most current U.S. EPA Residential RSLs (Table 2). These Action Levels proposed by the applicant and accepted by the VCP would be considered protective of human health and the environment for the proposed site land use.

In looking at the Site Investigation analytical data, arsenic was evaluated to assess if the detected concentrations are representative of Site background. As a Site-specific background level for arsenic is not available, various sources for background concentrations were evaluated. For the initial evaluation for arsenic, a value of 35 mg/kg (USGS Data Series 801: Geochemical and Mineralogical Data for Soils of the Conterminous United States and USGS Scientific Investigations Report 2017-5118: Geochemical and Mineralogical Maps, with Interpretation, for Soils of the Conterminous United States) is proposed.

Table 2
Proposed Action Levels for PAHs

ANTHRACENE	18,000 mg/kg
ACENAPHTHENE	3,600 mg/kg
ACENAPHTHYLENE	NA
BENZO(A)ANTHRACENE	1.1 mg/kg
BENZO(A)PYRENE	0.11 mg/kg
BENZO(B)FLUORANTHENE	1.1 mg/kg
BENZO(G,H,I)PERYLENE	NA
BENZO(K)FLUORANTHENE	11 mg/kg
CHRYSENE	110 mg/kg
DIBENZ(A,H)ANTHRACENE	0.11 mg/kg
FLUORANTHENE	2,400 mg/kg
FLUORENE	2,400 mg/kg
INDENO(1,2,3-CD)PYRENE	1.1 mg/kg
NAPHTHALENE	2.0 mg/kg
PHENANTHRENE	NA
PYRENE	1,800 mg/kg
1-METHYLNAPHTHALENE	18 mg/kg
2-METHYLNAPHTHALENE	240 mg/kg
<u>2-CHLORONAPHTHALENE</u>	<u>4,800 mg/kg</u>

NA = No RSL established for that compound.

3. REMEDIAL OBJECTIVES AND APPROACH

The objective of the remediation is to clean up the Property by removing the surface slag/ballast layer and any impacted soils located below the slag and transport the material off site for disposal at the Intermountain Regional Landfill (IRL), in Fairfield, Utah.

During cleanup, controls will be applied to minimize potential exposure to the slag and impacted soil by controlling wind-blown dust and soil track out on 500 West Street.

After remediation is completed, redevelopment of the Property will begin. Long term controls may be recorded on the Property to ensure the remedy remains protective of human health and the environment. The long-term controls may include an environmental covenant (EC) recorded on the Property, and a site management plan (SMP) which discusses procedures for annual inspections, reporting requirements, and procedures to address contingencies.

The remediation procedure selected has been successfully implemented at nearby remediation sites, which contained slag, including the Former Murray Smelter and Midvale Slag.

The remedial activities will be phased to minimize the handling of slag, and soil and to prevent potential re-contamination of areas which have been remediated by prohibiting transportation trucks and excavation equipment driving on the previously remediated areas. The proposed sequencing is as follows:

- Site preparation activities including installing informational signage, placement of trackout controls, installing site access controls, and asphalt removal.
- Excavation and placement into haul trucks of the vegetation grubbing, surface trash, slag ballast and the shallow soils located below the slag layer.
- Transportation of the slag and soil to the IRL facility. Procedures will be applied during relocation and placement of slag to prevent pulverizing slag into smaller grain size. All loads will be tarped during transportation.
- XRF screening and confirmation soil sample collection and laboratory analysis of soil which was located below the slag layer to demonstrate that the remaining soil meets Action Levels.
- Once all slag has been removed and transported to IRL and confirmation soil samples document that no additional material is present which does not meet Action Levels, the Project will be transferred to a grading and paving contractor.

Import of backfill is not anticipated during remediation activities. If backfill is required, it will be sourced from a well-established commercial pit and records of the backfill source will be documented in the RAP Completion Report.

4. CONFIRMATION SAMPLING AND ANALYSIS

This section identifies the methodologies that will be used to identify, evaluate, and relocate slag and soils impacted by lead and arsenic that will be removed and transported offsite for disposal at the Intermountain Regional Landfill.

During all soil and slag excavation activities, Wasatch will use an XRF analyzer continuously to measure lead and arsenic concentrations in the soils as they are excavated and placed into a dump truck. A Niton XL2 950 GOLDD (or equivalent) analyzer will be used following the U.S. EPA Method 6200 (Field Portable X-ray in situ soil screening). The XRF will be calibrated daily. Calibration will include:

- A blank sample composed of quartz sand or equivalent.
- Instrument energy calibration check
- Calibration verification checks, and
- Precision measurements

The XRF will be used for screening level sampling only. Laboratory analysis will be used to document that the concentrations of lead, arsenic, and PAHs met the action levels. Properly prepared soil samples will be submitted to a Utah-certified analytical laboratory for analysis of total lead and arsenic using U.S. EPA Method 6010 and PAHs with select ion monitoring (SIM) by U.S.EPA Method 8270.

Wasatch standard operating procedure (SOP) for the collection and screening of confirmation soil samples with an XRF (SOP)-1) is provided in Appendix A. A Quality Assurance Project Plan (QAPP) to be followed during sampling and analysis is attached in Appendix B.

As described in detail in the QAPP, quality control will be provided by following standardized sample collection, handling, and chain of custody documentation, using a Utah-certified analytical laboratory, and proper documentation of field activities. Additional soil sample collection including duplicate, split, and matrix spike/matrix spike duplicates will be analyzed and reviewed.

Prior to beginning excavation and loading activities, the slag will be wetted with water to avoid potential dust generation. Excavation activities will be staged to prevent potential re-contamination of areas which have been remediated by prohibiting transportation trucks and excavation equipment driving on the previously remediated areas.

Once all visible slag and impacted soil in that area has been removed, XRF measurements will be made of the soil which was directly beneath the slag and if the measurements indicate that the lead and arsenic concentrations in the residual soils meet the Action Levels, soil confirmation samples will be collected and prepared for laboratory submittal. As shown on Figures 5 and 6, the confirmation grids are labelled numerically 1 through 18 running north to south. A duplicate sample prepared from a grid location will be named by adding a zero to the grid numeral, except for a duplicate collected from grid numeral 1, which would be labelled 100 and a duplicate collected at confirmation grid 10, which would be labelled 1000.

A five-point composite soil confirmation sample will be collected from each grid area, using the numeric grid locations. Equal amounts of soil from each discrete location will be collected from the top two inches of soil, placed in a re-sealable plastic bag, and well mixed. One decontaminated trowel will be used to collect the five-point soil samples within each grid location. An un-used, decontaminated trowel will be used at each grid.

We anticipate collecting approximately 18 confirmation soil samples. Duplicate confirmation soil samples will be collected at a rate of 1 duplicate sample for every 10 confirmation samples.

The confirmation soil samples will be submitted to a Utah-certified analytical laboratory for analysis of total lead and arsenic by U.S. EPA Method 6020 and PAHs SIM by U.S. EPA Method 8270. The VCP Project Manager will be notified of all analytical results as they are received. Once the laboratory analysis is received and reviewed, any grid locations which do not meet the action levels will be additionally excavated, the soil transported offsite for disposal, and the grid resampled. The resample will be labelled with the original sample identification followed by "R".

5. POST REMEDIATION REPORTING

Following the completion of soil remediation activities, a Remedial Action Completion Report will be prepared for the Project.

5.1 Remedial Action Completion Report

The Remedial Action Completion Report will be prepared summarizing the activities completed following this Remediation Action Plan. The report will include site observations (e.g., distribution and concentrations of impacts, etc.), analytical results of XRF screening and laboratory confirmation soil sampling, site maps, documentation of volumes removed and disposed of, and any deviations from this Plan, and conclusions.

All data generated during implementation of this Remedial Action Plan will be documented in the Remedial Action Completion Report. This report will include the following:

- Field notes
- Chain-of-custody forms
- Laboratory analytical results
- XRF results, including QA/QC analysis and daily checks, in table format
- Laboratory quality control documentation and evaluation
- Sample location maps
- Documentation of Health and Safety Plan implementation and Fugitive Dust Control.

The results of the confirmation sampling and analysis will be summarized in the report. Data will be presented in tabular format. Conclusions based on the data as well as field observations will be included in the report. After the laboratory data has been received, reviewed, and evaluated for quality and usability, the report will be completed and sent as a draft to the Utah VCP for review. Any comments from the VCP will be incorporated, and a final report will be issued.

6. ADDITIONAL INFORMATION

6.1 Project/Task Organization

Mr. Dan Posilovich, Salt Lake City Metro, LLC is the manager responsible for overall implementation of the Former Provo Line soil remediation VCP project. DPS is the remediation contractor who will perform the soil remediation. They will report directly to Wasatch Environmental. DPS workers are all HAZWOPER trained and have worked on dozens of similar soil remediation projects. Wasatch is responsible to implement the removal of soil that does not meet the Action Levels, to collect confirmation samples for slag and soil removal as described in this plan and the QAPP. Mr. Christopher Nolan, P.G. is the senior project manager and will coordinate all phases of RAP implementation. Ms. Audra Heinzl is the QA/QC leader and is independent of the day-to-day management of the project.

Mr. Vince Stansfield, Mr. Jeff Hessburg, and Jake Scott are the Wasatch field personnel who will be on-site daily to implement fugitive dust control, keep detailed project notes, and collect required confirmation soil samples. Ms. Leigh Anderson of the Utah Voluntary Cleanup Program is the project manager overseeing this VCP project.

6.2 Project Task Description

Confirmation sampling results as described in Section 4 will be compared with the project established action limits for lead, arsenic, and PAHs to demonstrate that the VCP project goals have been met. Both XRF measurements and laboratory analytical results will be generated, reviewed, and compared to the action levels.

The project will begin in Summer 2023 once the 30-day public notice period is complete (see Section 6.17). It is anticipated that field screening with the XRF will begin once the impacted ballast and soil is excavated. Once excavated, it will be transported to the landfill along with any soil/slag mixes that do not meet the Action Levels. It is expected to take four weeks to excavate, load and transport the material for disposal at the Intermountain Regional Landfill.

Once approximately 3 confirmation sample grids have been cleared, confirmation sample collection will begin. Confirmation soil samples will be submitted to the analytical laboratory on a five-day requested turnaround time. Once all confirmation samples have been collected and results have been received and qualified, a Remedial Action Completion Report will be prepared. It is anticipated that the report will take approximately three weeks to prepare a draft report for review.

The entire project area containing soil impacts will be remediated and we don't anticipate any resource or time constraints.

6.4 Special Training/ Certifications

Special training is required for the Fugitive Dust Emissions Monitoring Plan implementation. Fugitive dust levels will be assessed using U.S. EPA Method 9 (Visual Determination of Opacity of Emissions from Stationary Sources) with is a certification which must be obtained every 6-months by completing Federal EPA Method 9 Visible Emissions Evaluation Course. Wasatch employees are current with their certification. Their certificates of completion will be contained in their training files at Wasatch.

6.5 Sampling Process Design

As described in Section 4, confirmation soil samples will be collected from surface soils during confirmation sampling. The confirmation sampling and grid (Figures 5 and 6) is based on approximately 90-foot by 60-foot grid locations, although some grids have been shifted or combined based on size. These sampling grid sizes were formulated in discussions with the VCP and are based on their experience with similar VCP projects involving lead, arsenic, and PAH impacts along railroad tracks. The numeric grid system will also be used to name each confirmation sample as described in Section 4. Table 9 in the QAPP summarizes sample type and anticipated number of samples to be collected. Soil samples will be delivered to the analytical laboratory within 48 hours of collection following chain-of-custody protocols.

Samples will be collected as five-point composite samples from ground surface to approximately 2-inches in depth. Equal volumes of soil will be placed in a labelled resealable plastic bag and well mixed to homogenize the sample.

All confirmation soil sampling is critical to demonstrating that the project action levels have been met. We do not anticipate that any confirmation sampling locations will be inaccessible.

Once source of variability is soil moisture. The laboratory analysis of the confirmation soil samples corrects for moisture, however XRF direct measurements do not correct for moisture. If winter conditions and/or soil moisture issues impact the XRF readings, soil will either be dried prior to XRF screening, or additional soil samples will be submitted for laboratory analysis and the results used to direct cleanup.

6.6 Sampling Methods

All soil screening with the XRF and soil confirmation sampling will follow Wasatch Standard Operating procedures (SOP-1).

Tables presented in the QAPP present the sample containers, analytical methods, sample jars, and sample volumes required. No sample preservative is used for metals or PAHs, although the samples will be placed on ice before and during transportation to the analytical laboratory.

The only sampling equipment that may require decontamination is soil trowels used to collect confirmation soil samples. One decontaminated trowel will be used to collect the five-point soil samples within each grid location. An un-used, decontaminated trowel will be used at each grid. The decontamination will follow SOP-3. The SOPs are presented in Appendix A.

If problems occur with the field measurement equipment, the field personnel will contact the Project Manager. The project may need to contact the equipment provider to trouble shoot the malfunction. If the malfunction cannot be solved, additional equipment will be ordered for next day delivery. If the XRF cannot be made functional, no additional soil screening will take place until a working, properly calibrated unit is available on-site.

6.7 Sampling Handling and Custody

Soil samples collected for laboratory analysis will be transferred by gloved hand from the resealable plastic bag in which they were composited directly into new, laboratory supplied and properly labeled 2 or 4-ounce sample jars. The samples will be placed on ice into a cooler and logged onto a chain-of-custody form. Custody of the samples will be maintained at all times until the samples are hand delivered to the laboratory service center. As well as the chain-of-custody form, all pertinent information regarding the sample collection and handling will be documented in the project logbook. Additional information on sample handling and chain-of-custody documentation is described in the QAPP.

6.8 Analytical Methods

The confirmation sample laboratory analysis will be performed at a Utah-certified analytical laboratory for analysis of total lead and arsenic by U.S. EPA Method 6020 and PAHs SIM by U.S. EPA Method 8270. All confirmation samples will be analyzed at Pace Laboratories under their Level 3 QA/QC program. Pace is located in Tennessee but has a service center located approximately 20 minutes from the Project site. A copy of their Quality Manual is attached to the .

6.9 Quality Control

Details of the quality control procedures are contained in the QAPP Sections 6 and 8. When control limits are exceeded on laboratory instrumentation, the instruments are recalibrated to within control limits prior to any sample analysis. If control limits are exceeded during sample batch QC, the data will be qualified and possibly the detection reporting limits raised. Wasatch will contact the laboratory if any data is qualified to evaluate if the data is useable for its intended purpose, or if re-sampling is required.

6.10 Equipment Testing, Inspection, and Maintenance

Procedures to test and maintain laboratory equipment are contained in the Pace Laboratories Quality Manual. The field equipment to be used includes the XRF. The XRF has no requirement for periodic maintenance. It is inspected and calibrated daily prior to use by the field scientist following SOP-1. If any unresolvable field equipment issues are encountered, the project manager will order replacement equipment from the supplier.

6.11 Equipment Calibration

Laboratory equipment is calibrated at a frequency discussed in the Pace Laboratories Quality Manual, attached as an appendix in the QAPP (Appendix B).

Field equipment (XRF) is calibrated daily following the SOPs. If the equipment does not properly calibrate, the equipment will be taken out of service, the reason for the removal will be documented in the field logbook, and the field scientist will call the Project Manager to order a replacement.

6.14 Fugitive Emissions Monitoring Plan

Dust control is a top priority for the successful completion of this remediation. Because of the potential of lead and arsenic in the soils being disturbed during the project, dust control is essential to prevent potential exposure of dust containing lead and/or arsenic to adjoining property's, workers, and on-site workers. The Project goal is to generate no visible dust during excavation and transportation of impacted material. The Remediation Contractor and Wasatch will be responsible for controlling fugitive dust emissions during the project and for implementing a State of Utah Division of Air Quality's approved Fugitive Dust Control Plan for the project.

Fugitive dust will be controlled using standard construction practices. Wetting the soils will be the primary control technology for fugitive dust emissions. If wetting the soils cannot control the fugitive emissions, additional dust-control measures will be implemented, which may include the following:

- Reducing on-site vehicle speeds
- Not entering remediated areas
- Limited drop heights when loading soil
- Reducing work activities
- Halting work if fugitive dust emissions cannot be controlled
- Wetting soil
- Tarping all loads exiting the site

To describe procedures to be used to monitor the effectiveness of dust control efforts during soil remediation activities, a detailed Fugitive Dust Control Plan has been prepared for the project. A copy of the FEMP is attached as Appendix C.

The plan's objective is to limit potential exposures to fugitive dust emissions to workers in areas adjacent to the UP Provo Line remediation, workers involved with soil remediation activities, and site workers not involved in soil remediation activities. Fugitive dust levels will be assessed using U.S. EPA Method 9 (Visual Determination of Opacity of Emissions from Stationary Sources). The results will be compared to the National Ambient Air Quality Standards and any applicable OSHA action levels.

6.15 Site Access

During RAP implementation the current site perimeter fencing will remain in place. One-point access to the north and south areas of the Project will be maintained along 500 West.

6.16 Contingency Plan

If during the subsurface work at the Property, potentially unidentified hazardous material, unexpected volumes or concentrations of material or substances not previously identified on the site are encountered, work will immediately stop, and the Remediation Contractor will contact Wasatch personnel if Wasatch is not present on site. Wasatch personnel will notify the Owner, the State of Utah VCP project manager, and propose a sampling plan to identify the material, review the Health and Safety Plan to ensure worker safety, and submit an action plan describing planned action to address the material. The contractor will not continue work in these areas until cleared by Wasatch personnel to proceed.

6.17 Public Notice and Community Outreach

A public notice informing the general public and owners of adjacent properties of the proposed remediation activities and how to obtain additional details of the proposed project has been prepared. A copy of the notice will be hand delivered to the adjoining property owners and will be published in the Salt Lake Tribune and Deseret News.

For community questions or concerns during remediation activities, a sign at the construction entrance will direct questions and/or comments to Mr. Ross Lingwell, Salt Lake City Metro (801) 598-2020.

Public Notice 30-Day Comment Period Former UP Provo Line Soil Remediation

Salt Lake City Metro, LLC has prepared a Remedial Action Plan (RAP) to address slag impacts at the proposed Former UP Provo Line project, located at 1000 South 500 West in Salt Lake City, Utah. Slag material used as rail ballast containing elevated arsenic, lead, and polynuclear aromatic hydrocarbons (PAHs) has been identified on site. The owner has entered into an agreement with the Utah Department of Environmental Quality (UDEQ), Division of Environmental Response and Remediation's (DERR's) Voluntary Cleanup Program (VCP) to remediate the soil to agree upon cleanup levels to allow unrestricted future use of the Property.

The RAP will describe procedures to manage soil and slag that will be disturbed during site re-development. An environmental covenant, a site management plan may be put in place to maintain the remedy and provide ongoing protection of human health and the environment.

During excavation work associated with the impacted soils, access to the site will be controlled and fugitive dust will be monitored to ensure the safety of workers and the community. It is anticipated that work will start in the Summer of 2023. Site remediation activities that may disturb impacted soils are anticipated to take approximately four weeks to complete.

All VCP documents including the RAP may be viewed online at <http://egedocs.utah.gov> or <https://deg.utah.gov/environmental-response-and-remediation/public-notices-utah-division-of-environmental-response-and-remediation#gen>, and at the Utah DEQ/DERR offices at the address below. The Public Comment period will commence on August 1, 2023, and comments will be received through August 31, 2023.

Please send written comments, either by mail or email to:

Ms. Leigh Anderson, Project Manager
Voluntary Cleanup/Brownfields Section
Division of Environmental Response and Remediation
Utah Department of Environmental Quality
P. O. Box 144840
195 North 1950 West, 1st Floor
Salt Lake City, Utah 84114-4840
kanderson@utah.gov
(385) 391-8144

6.18 Health and Safety Plan

Soil excavation and loading activities will adhere to specific project health and safety requirements. ATLAS has prepared a project specific Health and Safety Plan (HASP) and will provide worker training required by the Occupational Safety & Health Administration's (OSHA) Hazard Communication Standard (29 CFR 1910.1200) for arsenic and Lead in Construction Standard (29 CFR 1926.62) for lead. The HASP was prepared and reviewed by a Certified Industrial Hygienist. A copy of the Health and Safety Plan is presented in Appendix D.

6.19 Storm Water Low Erosivity Waiver Certification

The U.S. EPA stormwater regulations allow National Pollutant Discharge Elimination System (NPDES) permitting authorities (including Utah) to waive NPDES permitting requirements for stormwater discharges from small construction sites if the construction site disturbs less than five acres and the rainfall erosivity factor value is less than five during the construction period. This Project meets those requirements. A copy of the Low Erosivity Waiver Certification and Rainfall Erosivity Factor Calculator for Small Construction Sites is presented in Appendix E.

Although the requirements for a project-specific stormwater pollution prevention plan are not required, a trackout pad and straw waddles will be used to prevent spreading potentially impacted ballast or soil from the Project boundary offsite or to unimpacted areas.

Figures

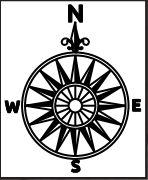

Vicinity Map

Figure 1

CURVE TABLE					
CURVE #	LENGTH	RADIUS	DELTA	CHD BRG	CHD LEN
C1	28.61	1935.08	0°50'49"	S19° 22' 13"W	28.61
C2	133.89	2798.13	2°44'30"	S21° 09' 51"W	133.87
C3	119.30	2734.14	2°30'00"	N21° 02' 37"E	119.29
C4	27.27	1871.08	0°50'06"	N19° 22' 34"E	27.27

**ALTA/NSPS LAND TITLE SURVEY
UNION PACIFIC RAILROAD
LOCATED IN THE WEST HALF OF SECTION 12,
TOWNSHIP 1 SOUTH, RANGE 1 WEST,
SALT LAKE BASE AND MERIDIAN
SALT LAKE CITY, SALT LAKE COUNTY, UTAH
MARCH 2023**

Figure 2

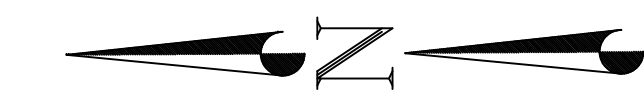

Found Street Monument
900 South / 500 West
Standard Flat Brass 3"

Found Street Monument
970 South / 500 West
Round Top Brass 2"

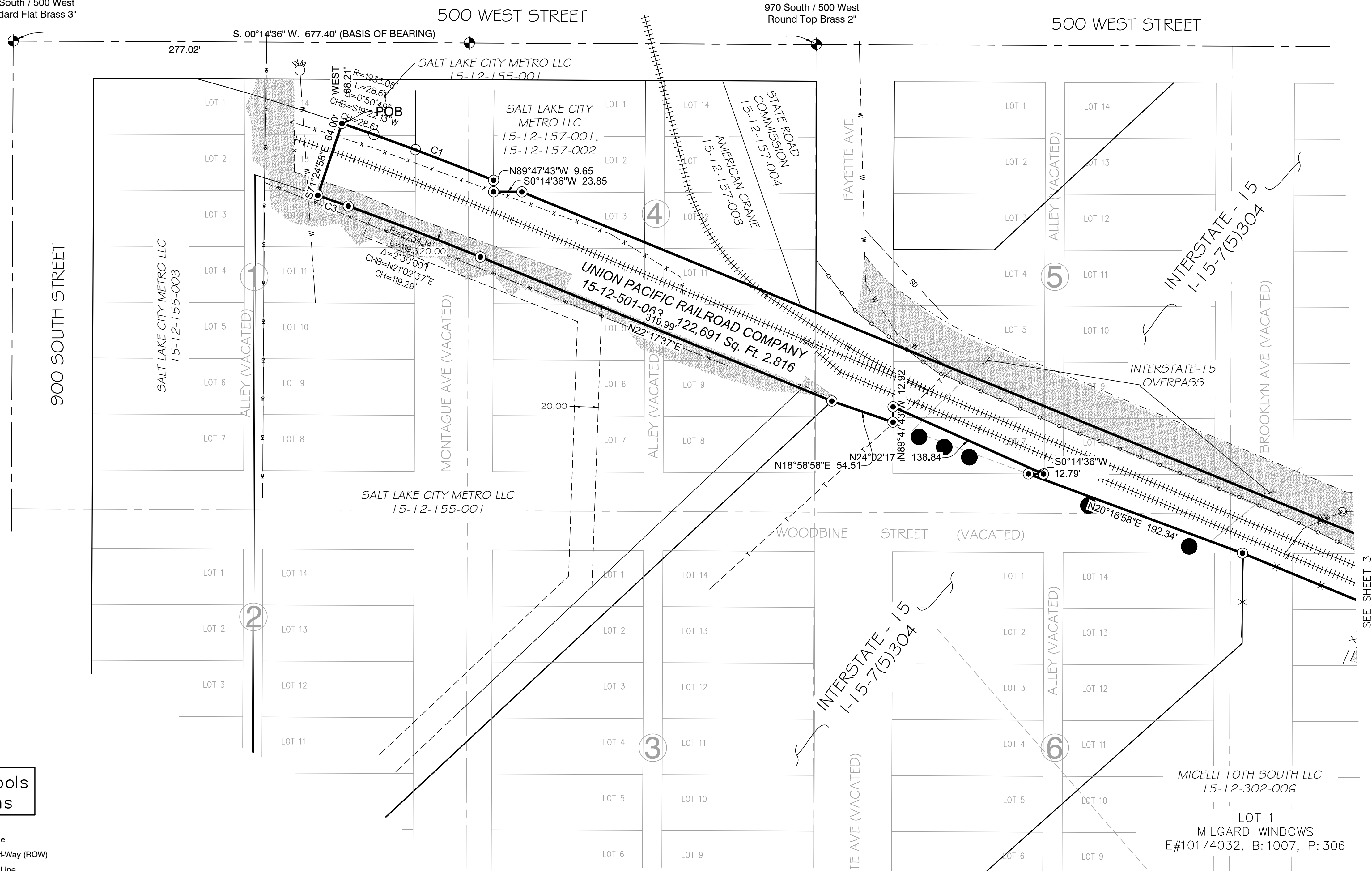

Legend of Symbols & Abbreviations

- Boundary Line
- Road Right-of-Way (ROW)
- Road Center Line
- Adjacent Parcel
- Existing Fence
- Curb and Gutter (C&G)
- Existing Sanitary Sewer
- Existing Storm Drain
- Existing Water
- Existing Telephone
- Concrete Barricade
- Set Rebar and Cap stamped "CIR PLS 5152617"
- Found Nail & Washer stamped GBE Ogen (Held)
- Asphalt
- Exception Number
- Overhead Light
- Sewer Manhole
- Storm Drain Manhole
- Access Point
- Concrete Bridge Column
- Water Valve
- Water Meter
- Gas Meter
- Water Manhole

Flood Note

By graphic plotting only, this property is in zone(s) AH (Special Flood Hazard Area) of the Flood Insurance Rate Map, Community Panel No. 49035C0281 E, which bears an Effective Date of September 21, 2001 and zone X (Other Flood Areas) of the Flood Insurance Rate Map, Community Panel No. 49035C0282 H, which bears an Effective Date of August 2, 2012.

Utility Note

The location of the utilities shown hereon are a combination of observed evidence of utilities above ground appurtenances and underground plans to determine the location of any subterranean uses. Lacking excavation, the exact location of underground features could not be accurately, completely, and reliably depicted.

Zoning Note

This surveyor was not provided with current zoning classification and building setback requirements, height and floor space area restrictions as set forth in that classification, as provided by the insurer; thus, these items are not shown hereon.

NO.	DATE	DESCRIPTION OF REVISION	INITIAL

GRAPHIC SCALE
0 50 100 150
(IN FEET)
1"=50'

Prepared By: BP Date: 03/06/23
Surveyed By: GC Date: 09/26/20
Checked By: GC Date: 03/06/23

ALTA/NSPS LAND TITLE SURVEY
UNION PACIFIC RAILROAD

Prepared for:
POSLOVICH

West Half, Section 12, T1S., R1W., S.L.B. & M.

PREPARED BY:
CIR CIVIL ENGINEERING + SURVEYING
10718 South Beckstead Lane, Suite 102, South Jordan, UT 84095
Phone: 435-503-7641

Figure 1

SHEET NO. 2 OF 3

SVY

PROJECT ID: S23-043 DATE: 03/03/2023
FILE NAME:

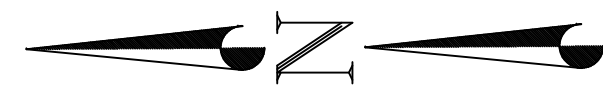

**ALTA/NSPS LAND TITLE SURVEY
UNION PACIFIC RAILROAD
LOCATED IN THE WEST HALF OF SECTION 12,
TOWNSHIP 1 SOUTH, RANGE 1 WEST,
SALT LAKE BASE AND MERIDIAN
SALT LAKE CITY, SALT LAKE COUNTY, UTAH
MARCH 2023**

**Legend of Symbols
& Abbreviations**

- Boundary Line
- Road Right-of-Way (ROW)
- Road Center Line
- Adjacent Parcel
- Existing Fence
- Curb and Gutter (C&G)
- Existing Sanitary Sewer
- Existing Storm Drain
- Existing Water
- Existing Telephone
- Set Rebar and Cap stamped "CIR PLS 5152617"
- Found Nail & Washer stamped GBE Ogden (Held)
- Asphalt
- Exception Number
- Overhead Light
- Sewer Manhole
- Storm Drain Manhole
- Access Point
- Concrete Bridge Column
- Water Valve
- Water Meter
- Gas Meter
- Water Manhole

500 WEST STREET

500 WEST STREET

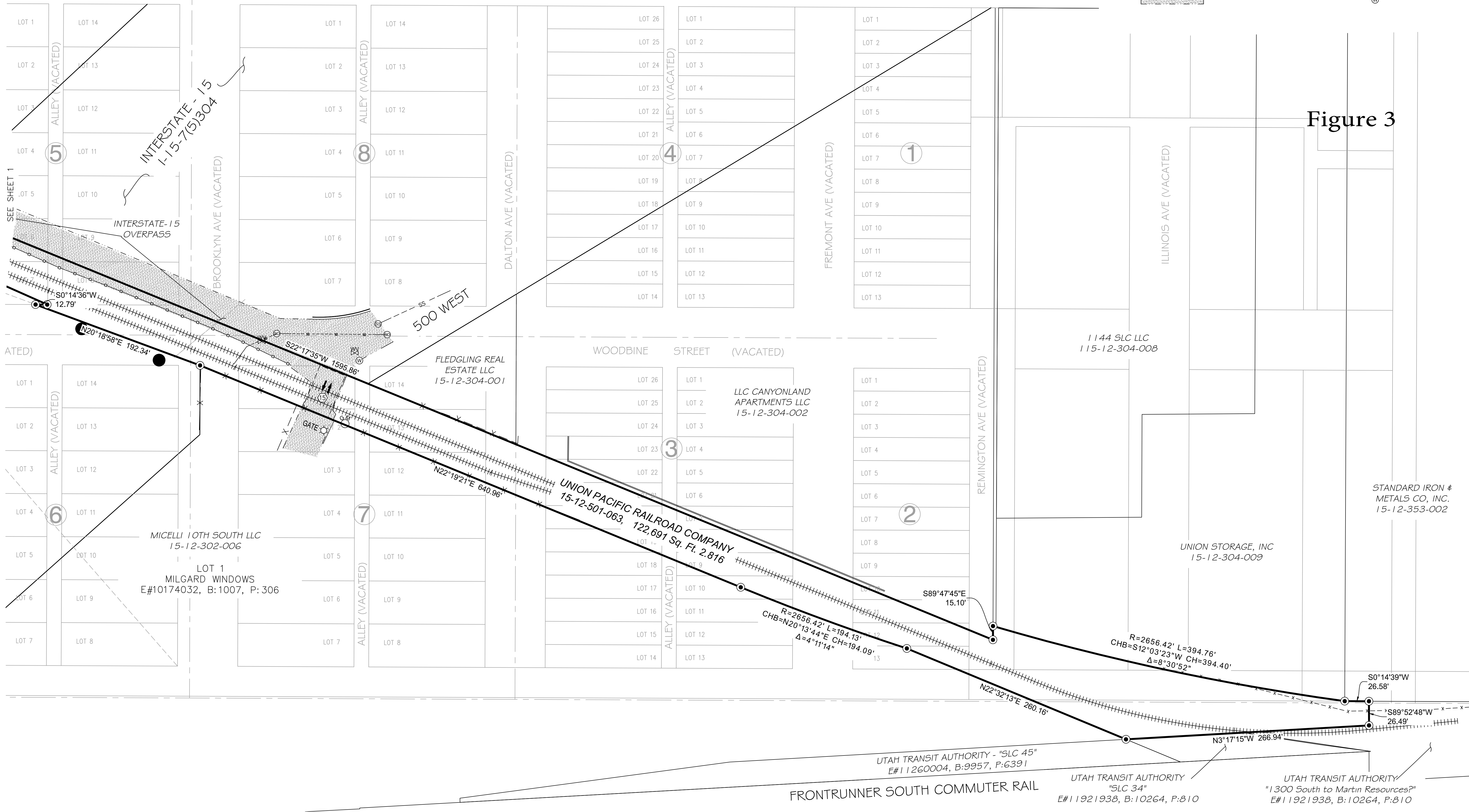

Figure 3

NO.	DATE	DESCRIPTION OF REVISION	INITIAL

GRAPHIC SCALE
 0 50 100 150
 (IN FEET)
 1"=50'

Prepared By: BP Date: 03/06/23
 Surveyed By: GC Date: 09/26/20
 Checked By: GC Date: 03/06/23

ALTA/NSPS LAND TITLE SURVEY
UNION PACIFIC RAILROAD

Prepared for:
POSLOVICH

West Half, Section 12, T1S., R1W., S.L.B. & M.

**CIVIL ENGINEERING
+ SURVEYING**

CIR

10718 South Beckstead Lane, Suite 102, South Jordan, UT 84095
Phone: 435-503-7641

C:\Users\jgibson\OneDrive\Documents\ALTA_Survey\altda\altda_2023\altda_2023\altda_2023_413.dwg

POSILOVICH ENTERPRISES FORMER UP RAIL SPUR WEI 2493-001

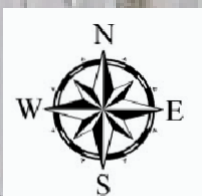

■ Test Pit Location
● Boring Location

Sample Location Map Figure 4



Found Street Monument
900 South / 500 West
Standard Flat Brass 3"

Found Street Monument
970 South / 500 West
Round Top Brass 2"

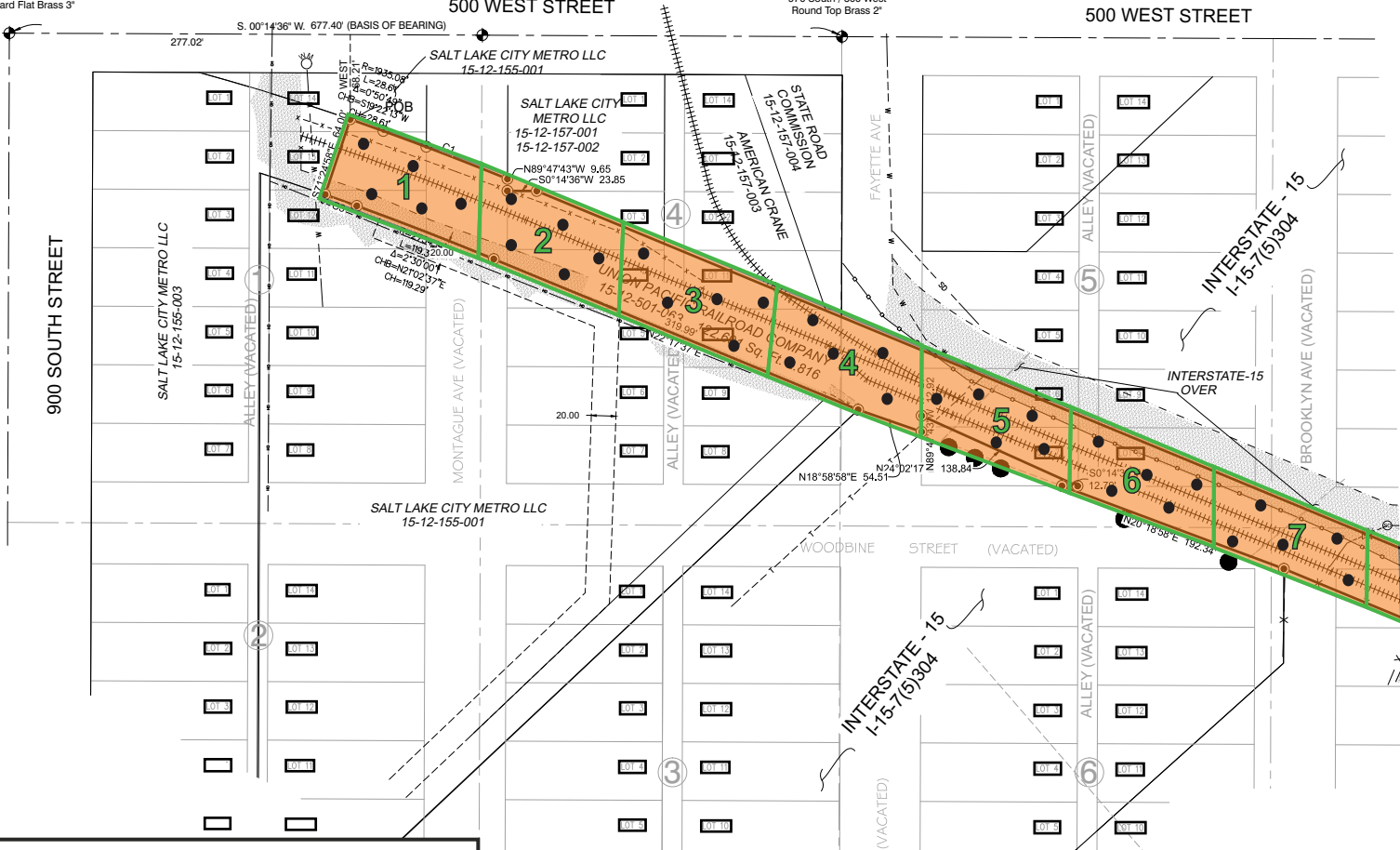

LEGEND

- General Area of Railroad Spur
- Surface Soil Composite Sample Area
- Composite Aliquot Sample Location

Confirmation Sample Location Map

Figure 5

FORMER UP RAIL SPUR WEI 2493-001

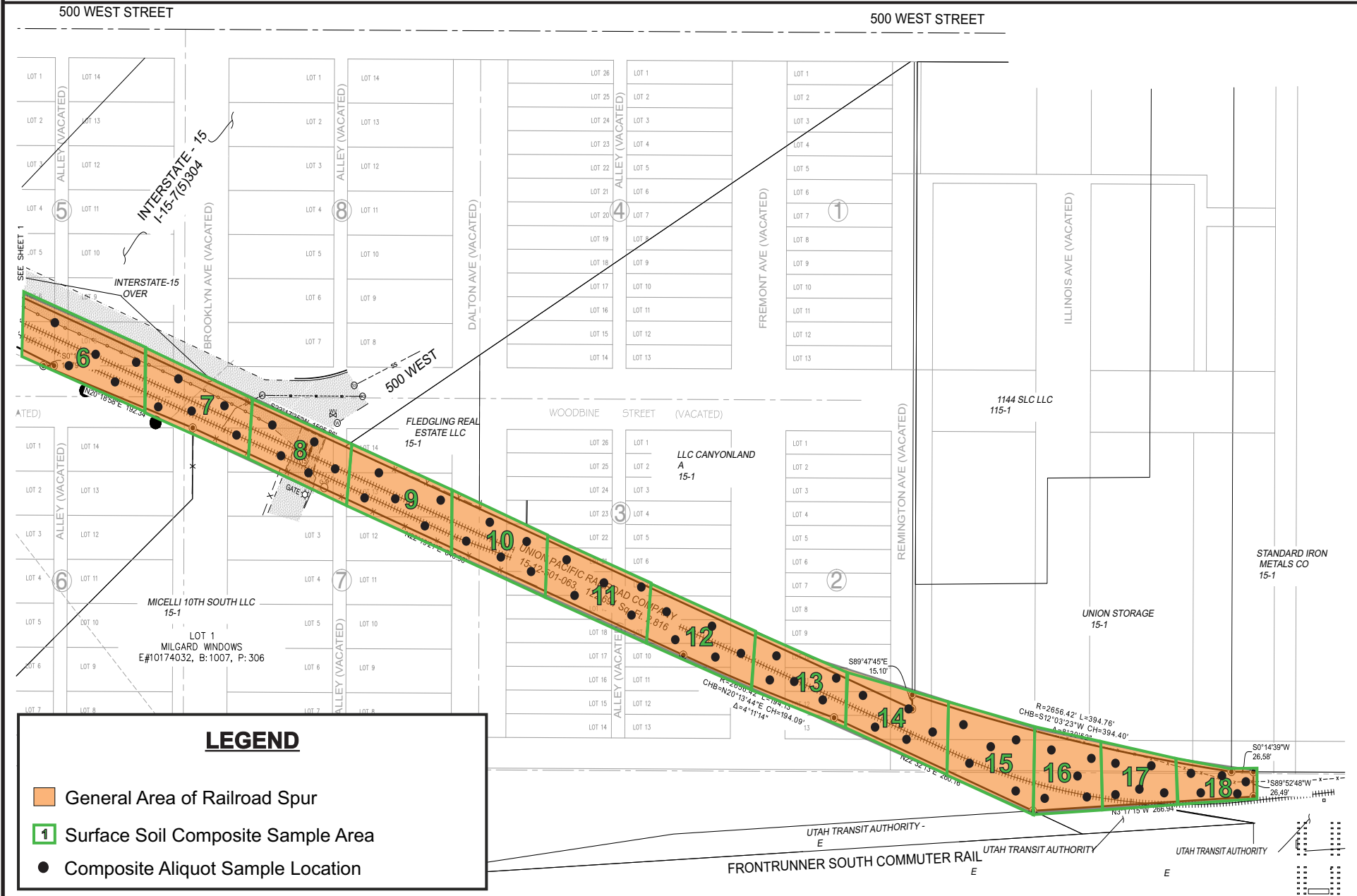

LEGEND

- General Area of Railroad Spur
- Surface Soil Composite Sample Area
- Composite Aliquot Sample Location

Confirmation Sample Location Map South Figure 6

Appendix A

Standard Operating Procedures

SOP-1

SOP-3

SOP – 1 XRF SCREENING FOR HEAVY METALS

X-ray fluorescence (XRF)

Under this method, inorganic metals of interest in soil are identified and quantitated using a field-portable, energy-dispersive, x-ray fluorescence spectrometer. Radiation from one or more radioisotope sources or an electrically excited x-ray tube is used to generate characteristic x-ray emissions from elements in a sample. Up to three sources may be used to irradiate a sample. Each source emits a specific set of primary x-rays that excite a corresponding range of elements in a sample. When more than one source can excite the element of interest, the source is selected according to its excitation efficiency for the element of interest.

Wasatch will use a Niton XL2 950 GOLDD analyzer (or equivalent) following the U.S. EPA Method 6200 (Field Portable X-ray Fluorescence Spectrometry for the Determination of Elemental Concentrations in Soil and Sediment) for *in situ* soil screening. The handheld meter will be used to directly measure the concentrations of the metals of concern in soil. A 30-second measurement time will be used to screen the soil during soil removal activities.

The XRF will be checked each day of use for energy calibration, instrument blank, method blank and calibration checks.

The energy calibration check would be run at a frequency consistent with manufacturer's recommendations. The energy calibration check procedures are as follows:

1. Power up the XRF
2. Press "Yes" to proceed
3. Log on with the password: 1,2,3,4
4. From the "Take a Measurement" (home) screen, touch "System Check"
5. Touch "Perform a System Check"
6. XRF will perform 2 system checks. **Please note that the amber active lights are on during this procedure. DO NOT POINT the XRF at yourself or anyone else during this procedure.**

Generally, this would be at the beginning of each working day, after the batteries are changed or the instrument is shut off, at the end of each working day, and at any other time when the instrument operator believes that drift is occurring during analysis.

An instrument blank is used to verify that no contamination exists in the spectrometer or on the probe window. The instrument blank can be silicon dioxide, a polytetrafluoroethylene (PTFE) block, a quartz block, clean sand, or lithium carbonate. The instrument blank would be analyzed on each working day before and after analyses are conducted and once per every twenty samples. The instrument blank is labeled "SiO₂ 99.995% PP, 180-647".

A method blank is used to monitor for laboratory-induced contaminants or interferences. The method blank can be clean silica sand or lithium carbonate that undergoes the same preparation procedure as the samples. A method blank would be analyzed at least daily. The method blank is labeled "180-706, USGS SdAR-M2, control sample".

Calibration verification checks should be conducted at least three times per day. This would be the same timetable as the energy calibration check with additional checks for substantial ambient temperature changes. The samples are labeled "RCRApp, 1000Ba 500Ag, As, Cd, Cr, Pb, Se 180-661" or field samples labeled with known Pb and As values. A 30-second measurement time is used on the samples and analysis should be within +/- 20% of the listed values. The Niton XL2 950 GOLDD is only calibrated at the factory and this is only a check for drift during analysis.

XRF In Situ Field Operation for Soils and Sediments:

1. After beginning checks have been completed, select "Sample Type" from the "Take a Measurement" home screen.
2. Select "Soils and Minerals" and then select "Soils"
3. "Ready to Test" will be displayed along with a camera view of analysis area.
4. Prepare the surface to be tested by leveling the area to be tested with a trowel or shoe.
5. Place XRF directly against soil surface and pull the trigger to activate XRF
6. Use a 30-second measurement time to test the selected area. If it is not feasible to use a 30-second measurement time due to the excavation crew's work, a shorter measurement time can be used but the error range increases as measurement time decreases.
7. While analysis is underway, and the active amber lights are displayed, avoid placing hands or feet at the sides or above the XRF to minimize exposure to X-Rays.
8. Minerals will be displayed on the viewing screen with Lead and Arsenic listed first (if present) followed by minerals by concentration.
9. If required, record shot number, displayed on the top left-hand side of viewing screen, and the location.

XRF Composite Soil and Sediment Analysis:

1. Using a clean trowel, shovel or gloved hands, collect samples from composite area and place in a plastic freezer bag.
2. Mix the soil thoroughly in the bag and remove gravel or crush larger clumps of soil to achieve a semi-uniform grain size.
3. Distribute soil evenly throughout bag and place on a non-metal surface.
4. Analyze different sections of the bag for 30-seconds per shot and record the shot numbers. The thinner the plastic of the bag, the more accurate the XRF analysis.

Moisture content may affect the accuracy of XRF analysis of soil and sediments. When moisture content is below 20%, the overall error from moisture may be minimal. However, moisture content may be a major source of error when analyzing samples of surface soil or sediment that are saturated. Our experience has shown that moisture content inversely affects the analysis, the higher the moisture content the lower the analysis values. If soils are saturated, they can be brought back from the field and dried in a toaster oven, then analyzed per the composite soil and sediment instructions listed above.

Additional details are provided in the U.S. EPA method 6200 documentation.

SOP 03 – DECONTAMINATION

Equipment used to advance soil borings, and obtain soil and groundwater samples, will be decontaminated to avoid cross-contamination. Downhole equipment will be pressure-cleaned with potable water and Alconox® (or other equivalent cleaner) before drilling and sampling of each borehole. The cleaning of equipment will typically be performed at the site.

Soil trowels, bailers, submersible pumps and other non-dedicated miscellaneous equipment, that contacts analytical soil or groundwater samples, will be decontaminated or replaced with new material before and between each sampling event. Equipment of this type may be decontaminated by cleaning, when convenient, but is typically decontaminated using the following three-step procedure:

- Laboratory-grade detergent, such as Alconox®, and potable water wash
- Potable water rinse
- Triple rinse with distilled water or deionized water

Spray bottles may be used to store and apply the distilled or deionized water. If necessary, sampling equipment will be wrapped with aluminum foil to protect the equipment from dust or vapors between use. Liquids generated during the decontamination process will be handled according to the **Management of Investigation-Derived Waste SOP** when required.

Appendix B

Quality Assurance Project Plan

Appendix C

Fugitive Emissions Monitoring Plan

Appendix D
Health and Safety Plan

Appendix E

Stormwater Low Erosivity Waiver Documentation

LOW EROSIONITY WAIVER (LEW) CERTIFICATION

This certification stands in lieu of a UPDES storm water permit for construction activity for small construction activity.

STATE OF UTAH, DEPARTMENT OF ENVIRONMENTAL QUALITY, DIVISION OF WATER QUALITY 195 N. 1950 W. , P.O. Box 144870, SALT LAKE CITY, UTAH 84114-4870

Submission of this Low Erosivity Waiver Certification constitutes notice that the entity identified in Section B does not require permit authorization for its storm water discharges associated with construction activity in the State of Utah due to the existence of a low erosivity factor (less than 5) at the site of soil disturbance. This waiver applies only to "small construction activity" which is defined as soil disturbances due to construction activity that are 1 acre or greater but less than 5 acres. Small construction activity also includes disturbances of less than one acre if it is part of a common plan of development or sale that is less than 5 acres. Remember, disturbances of less than one acre, if it is not part of a common plan of development or sale, is not required to have permit authorization. Submission of this form does not relieve the operator of permitting requirements for other regulated activities/discharges which may pertain to the construction activity (e.g. dewatering activities, non-storm water discharges, etc.)

An erosivity factor can be calculated from the EPA calculator at <https://lew.epa.gov/> or it can be done by hand using the instructions from the EPA Fact Sheet entitled, Storm water Phase II Final Rule: Construction Rainfall Erosivity Waiver (which is posted on the DWQ construction storm water web page). The EPA fact sheet also explains where the erosivity factor comes from. The information needed to calculate an erosivity factor is the start and end date of construction activities, and the latitude and longitude for the project site (or another acceptable way of pinpointing the location of the project site – see the EPA calculator). The waiver is meant for sites that can predictably be completed within the specified time period (the time between the dates used to calculate the erosivity factor). If delays or unforeseen circumstances prolong the construction time of completion and the project is not completed by the projected completion date, the operator must immediately submit application for coverage under the Utah Pollutant Discharge Elimination System (UPDES) General Permit for Storm Water Discharges Associated with Construction Activities, or recalculate the erosivity factor and confirm that the newly calculated erosivity factor is less than 5.

The cost for an erosivity waiver is \$100. The preferred method for paying is to obtain the waiver on line with Visa/Master Card at <http://construction.stormwater.utah.gov>, but it can be paid by check/cash if submitted with a paper form and dropped off at DWQ, 195 N. 1950 W., SLC, UT 84116, or via check only with paper form if mailed to PO Box 144870, SLC, UT 84114.

1. CONTACTS INFORMATION

Owner Name Salt Lake City Metro, LLC
Address 750 The City Drive, Suite 320
City Orange State CA ZIP 92868
Contact Person Daniel R. Posilovich
Contact Person Title Owner
Address 750 The City Drive, Suite 320
City Orange State CA ZIP 92868
Telephone Number 714-290-3800
Owner Status Private (Private/State/Federal)
Email address (the address which is best for conveying messages if needed): cn@wasatch-environmental.com

Gen Contractor Name Direct Push Services, Inc.
Address PO Box 25784
City Salt Lake City State UT ZIP 84125
Contact Person Dusty Swank
Contact Person Title Scheduler
Address PO Box 25784
City Salt Lake City State UT ZIP 84125
Telephone Number 801-372-7613

2. PROJECT INFORMATION

Start Date 10 Jul 2023 Completion Date 13 Oct 2023
Project Site Name Union Pacific Railroad Provo Line
Method of Calculation lew.epa.gov
Calculated Erosivity Factor 3.63
Latitude 40.74446 Longitude -111.90803
Project Address Extending SW for a distance of approx. 2040' beginning at a point approx. 240' SW of the intersection of 900 S and 500 W
City Salt Lake City County Salt Lake
State UT ZIP 84101
Project Type (Linear/Residential/Commercial/Industrial/Other)
Municipal Separate Storm Sewer System (MS4) Operator Name: Salt Lake City
Acres Disturbed 2.80 plus or minus

Completion Date: The date when the site is permanently stabilized (see part 2.6 of the Common Plan Permit).

- *For areas in Utah with annual precipitation over 20 inches, that means all soils have permanent cover (pavement, structures, etc.), or have uniform revegetated cover of at least 70% of indigenous vegetation.*
- *For areas in Utah with annual precipitation less than 20 inches, that means all areas that are not covered (paved, structures, etc) must be seeded. Slopes 5 % to 20% must have energy dissipation for drainage pathways. Slopes over 20% and greater must have non-vegetative surface stabilization (mulch, gravel, erosion blanket, etc.).*

Signature _____

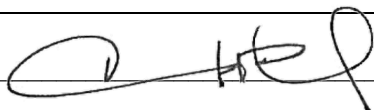

Date 6/20/23

Rainfall Erosivity Factor Calculator for Small Construction Sites

EPA’s stormwater regulations allow NPDES permitting authorities to waive NPDES permitting requirements for stormwater discharges from small construction sites if:

- the construction site disturbs less than five acres, and
- the rainfall erosivity factor (“R” in the revised universal soil loss equation, or RUSLE) value is less than five during the period of construction activity.

If your small construction project is located in an area where EPA is the permitting authority and your R factor is less than five, you qualify for a low erosivity waiver (LEW) from NPDES stormwater permitting. If your small construction project does not qualify for a waiver, then NPDES stormwater permit coverage is required. Follow the steps below to calculate your R-Factor.

LEW certifications are submitted through the NPDES eReporting Tool or “CGP-Net”. Several states that are authorized to implement the NPDES permitting program also accept LEWs. Check with your state NPDES permitting authority for more information.

- [Submit your LEW through EPA’s eReporting Tool](#)
- [List of states, Indian country, and territories where EPA is the permitting authority \(pdf\)](#)
- [Construction Rainfall Erosivity Waiver Fact Sheet](#)
- [Small Construction Waivers and Instructions \(pdf\)](#)

The R-factor calculation can also be integrated directly into custom applications using the [R-Factor web service](#).

For questions or comments, email EPA’s CGP staff at cgp@epa.gov.

 Select the estimated start and end dates of construction by clicking the boxes and using the dropdown calendar.

The period of construction activity begins at initial earth disturbance and ends with final stabilization.

Start Date: **End Date:**

 Locate your small construction project using the search box below or by clicking on the map.

Location: **Search**





Click the "Calculate R Factor" button below to calculate an R Factor for your small construction project.

Calculate R Factor

Facility Information

Start Date: 07/10/2023	Latitude: 40.7445
End Date: 10/13/2023	Longitude: -111.9080

Calculation Results

Rainfall erosivity factor (R Factor) = **3.63**

A rainfall erosivity factor of less than 5.0 has been calculated for your site and period of construction. If you are located in an [area where EPA is the permitting authority \(pdf\)](#), you can submit a LEW through EPA's [NPDES eReporting Tool \(NeT\)](#). Otherwise, contact your state permitting authority to determine if you are eligible for a waiver from NPDES permitting requirements.

If you submitted a LEW through EPA's NeT and your construction activity ultimately extends past the project completion date you specified above, you must recalculate the R factor using the original start date and a new project completion date. If the recalculated R factor is still less than 5.0, you must submit a modification to your LEW through NeT before the end of the original construction period. If the new R factor is 5.0 or greater, you must submit a Notice of Intent (NOI) instead to be covered by the Construction General Permit (CGP) before the original project completion date.